

2SK2130

Silicon N-Channel Power F-MOS FET

■ Features

- Avalanche energy capacity guaranteed: $E_{AS} > 15\text{mJ}$
- $V_{GSS} = \pm 30\text{V}$ guaranteed
- High-speed switching: $t_f = 45\text{ns}$
- No secondary breakdown

■ Applications

- Contactless relay
- Diving circuit for a solenoid
- Driving circuit for a motor
- Control equipment
- Switching power supply

■ Absolute Maximum Ratings ($T_C = 25^\circ\text{C}$)

Parameter	Symbol	Ratings	Unit	
Drain to Source breakdown voltage	V_{DSS}	900	V	
Gate to Source voltage	V_{GSS}	± 30	V	
Drain current	DC	I_D	± 3	A
	Pulse	I_{DP}	± 6	A
Avalanche energy capacity	E_{AS}^*	15	mJ	
Allowable power dissipation	$T_C = 25^\circ\text{C}$	P_D	50	W
	$T_a = 25^\circ\text{C}$		2	
Channel temperature	T_{ch}	150	$^\circ\text{C}$	
Storage temperature	T_{stg}	-55 to +150	$^\circ\text{C}$	

* $L = 5\text{mH}$, $I_L = 2.45\text{A}$, $V_{DD} = 50\text{V}$, 1 pulse

■ Electrical Characteristics ($T_C = 25^\circ\text{C}$)

Parameter	Symbol	Conditions	min	typ	max	Unit	
Drain to Source cut-off current	I_{DSS}	$V_{DS} = 720\text{V}$, $V_{GS} = 0$			0.1	mA	
Gate to Source leakage current	I_{GSS}	$V_{GS} = \pm 30\text{V}$, $V_{DS} = 0$			± 1	μA	
Drain to Source breakdown voltage	V_{DSS}	$I_D = 1\text{mA}$, $V_{GS} = 0$	900			V	
Gate threshold voltage	V_{th}	$V_{DS} = 25\text{V}$, $I_D = 1\text{mA}$	2		5	V	
Drain to Source ON-resistance	$R_{DS(on)}$	$V_{GS} = 10\text{V}$, $I_D = 2\text{A}$		3.8	5	Ω	
Forward transfer admittance	$ Y_{fs} $	$V_{DS} = 25\text{V}$, $I_D = 2\text{A}$	1.5	2.2		S	
Diode forward voltage	V_{DSF}	$I_{DR} = 3\text{A}$, $V_{GS} = 0$			-1.6	V	
Input capacitance (Common Source)	C_{iss}	$V_{DS} = 20\text{V}$, $V_{GS} = 0$, $f = 1\text{MHz}$		600		pF	
Output capacitance (Common Source)	C_{oss}				90		pF
Reverse transfer capacitance (Common Source)	C_{rss}				30		pF
Turn-on time (delay time)	$t_{d(on)}$	$V_{GS} = 10\text{V}$, $I_D = 2\text{A}$ $V_{DD} = 200\text{V}$, $R_L = 100\Omega$		40		ns	
Rise time	t_r			40		ns	
Fall time	t_f				45		ns
Turn-off time (delay time)	$t_{d(off)}$				100		ns
Thermal resistance between channel and case	$R_{th(ch-c)}$				2.5	$^\circ\text{C/W}$	

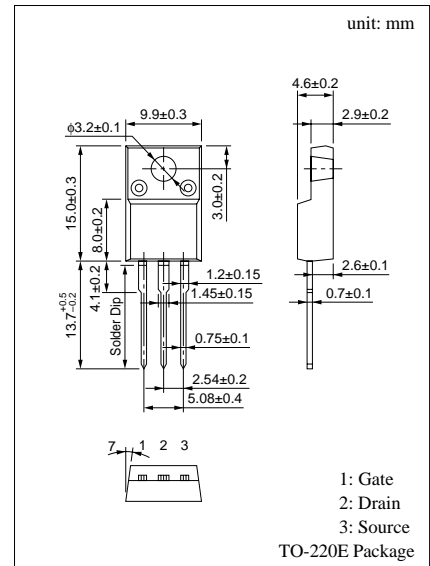

Area of safe operation (ASO)

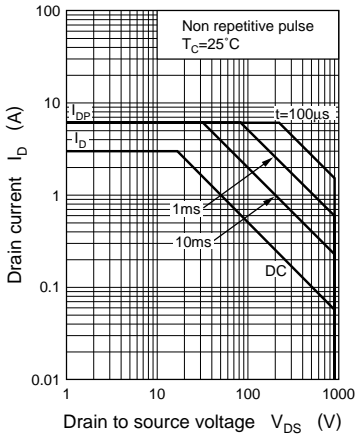

$P_D - T_a$

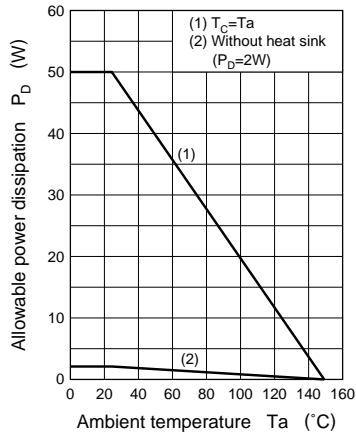

EAS — T_j

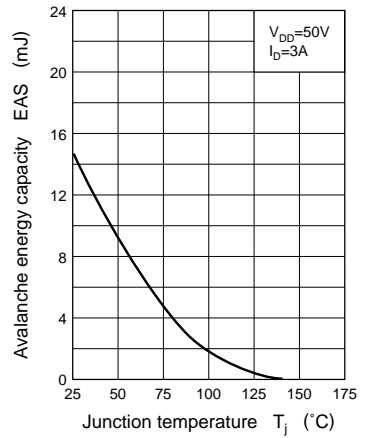

$I_D - V_{DS}$

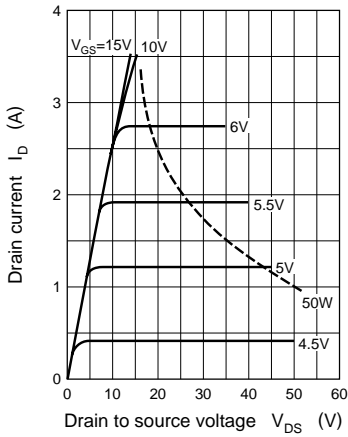

$I_D - V_{GS}$

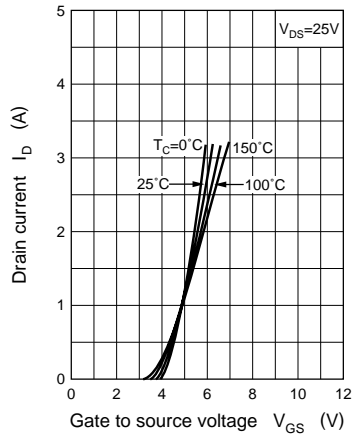

$V_{th} - T_C$

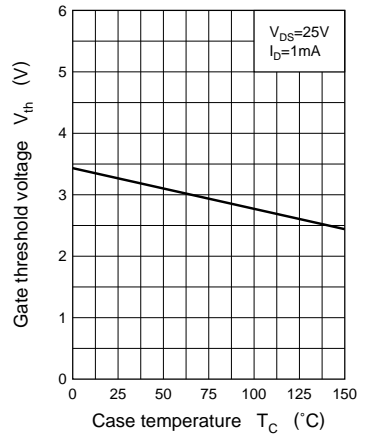

$V_{DS} - V_{GS}$

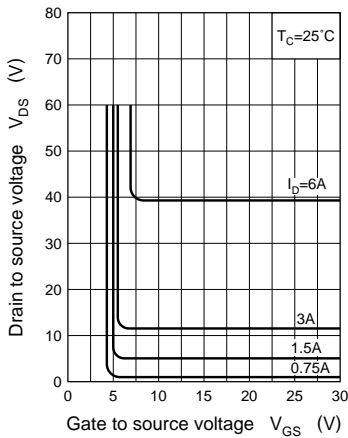

$R_{DS(on)} - I_D$

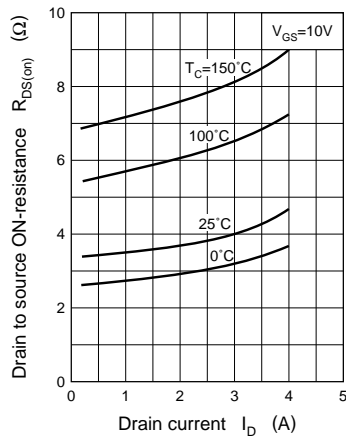

$|Y_{fs}| - I_D$

